

RELIABLE RINSING OF TANKS AND EQUIPMENT INSTALLATIONS

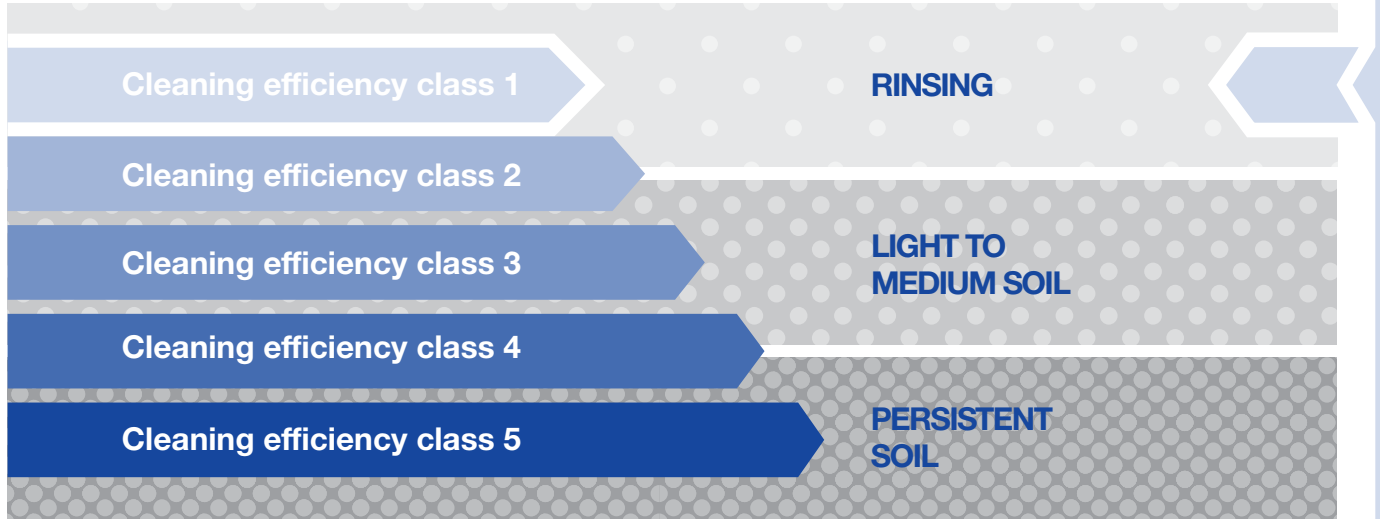

Cleaning efficiency class 1

These static spray balls of cleaning efficiency class 1 are designed for hygienic rinsing with a flow rate of 15 to 670 l/min at 2 bar, as is frequently required in the food and beverage industry. In addition to liquid media, the static spray balls can also be operated with media such as steam and air and therefore

are especially suitable for SIP cleaning (Sterilization in Place).

Lechler products in this class are also designed for operation at higher temperatures and guarantee high process reliability.



 **Operating principles**
Static

 **Flow rates at 2 bar**
15 to 670 l/min

 **Recommended operating pressures**
1.5 to 3 bar

 **Max. temperatures**
to 200 °C



Static spray balls Series 527

Series 527

The 3-A certification also makes the products of series 527 suitable for areas with the highest of hygiene requirements. They clean with powerful solid jets, have a high surface quality and are also reliably resistant to high temperatures.



	Max. tank diameter [m]	0	1	2	3	4	5	6	7	8	9
--	-------------------------------	---	---	---	---	---	---	---	---	---	---



Material
316L SS



Max. temperature
200 °C



Recommended operating pressure
1.5 bar



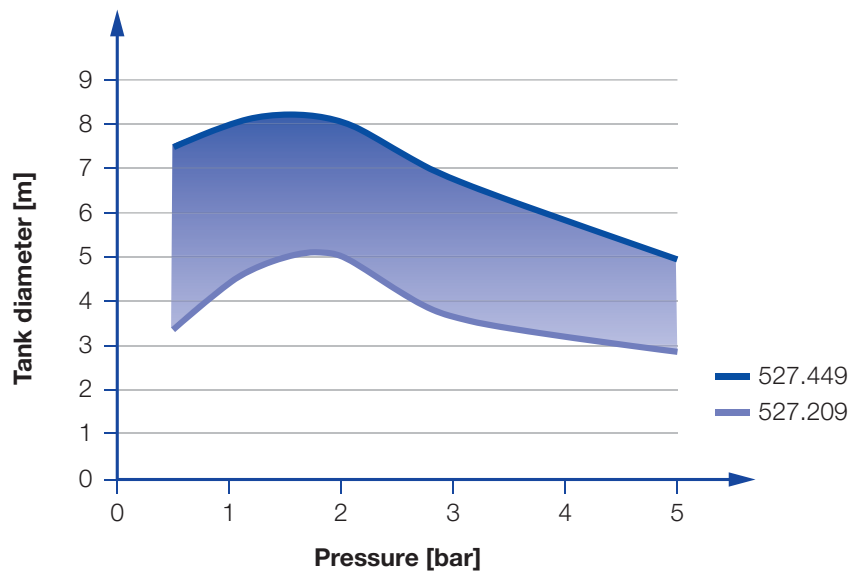

Installation
Operation in every direction is possible

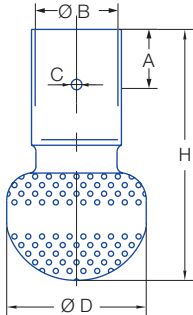

Overview of the tank diameter, depending upon the pressure of series 527



Dimensions slip-on connection according to ASME-BPE (OD-tube)

Spray angle 	Ordering number Type	E Ø [mm]	\dot{V} [l/min]					Dimensions approx. [mm]					Max. tank diameter [m]
			p [bar] ($p_{\max} = 5$ bar)					Height H	Ø D	Ø B	Ø C	Ø A	
			1	2	3	5	at 40 psi [US gal/min]						
	527.209.1Y.00.75	0.8	42	60	73	95	19	68	32	19.0	3.3	12.7	5.2
	527.289.1Y.01.50	1.1	120	170	208	269	50	116	65	38.3	4.9	25.4	6.0
	527.449.1Y.02.00	1.7	297	420	514	664	127	152	102	51.0	4.9	25.4	8.2

E = narrowest free cross-section

The maximum tank diameter shown above applies for the recommended operating pressure and is indicative only. The cleaning result is also affected by the type of soiling.

Information on operation

In most applications, static spray balls do not deliver the same cleaning power as rotating nozzles, anyway they do have advantages that make them indispensable for certain tasks:

- No moving parts
- Self-draining
- Easy to inspect
- Proven use in hygienically sensitive environments

Should a rotating nozzle stop turning for some reason, parts of the tank may remain uncleaned. This cannot happen with spray balls. However, gaps can occur in the spray pattern if individual openings are blocked with soil.

Compared to rotating nozzles, static spray balls usually need two to three times the amount of liquid.

Slip-on information

- R-clip made of 316L SS is included.
- Depending on diameter of the adapter the flow rate can increase due to leakage between connecting pipe and static spray ball.



Static spray balls Series 540/541

Series 540/541

The robust series 540/541 have a threaded connection and an especially compact design. They can also be used at high temperatures as well as for the output of steam and air.

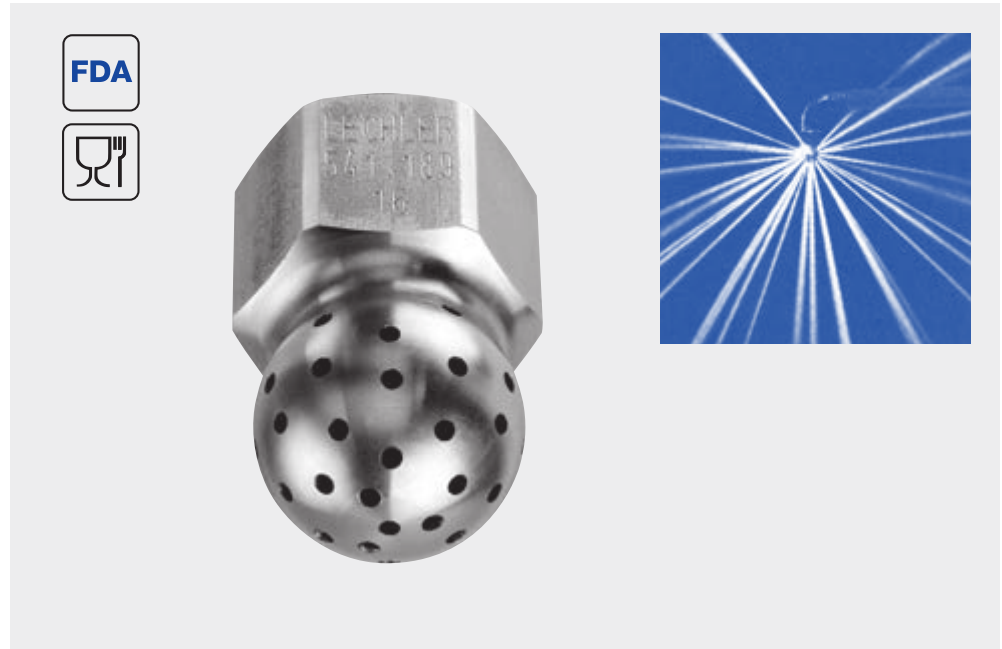

Max. tank diameter [m]



Material
303 SS



Max. temperature
200 °C



Recommended operating pressure
3 bar



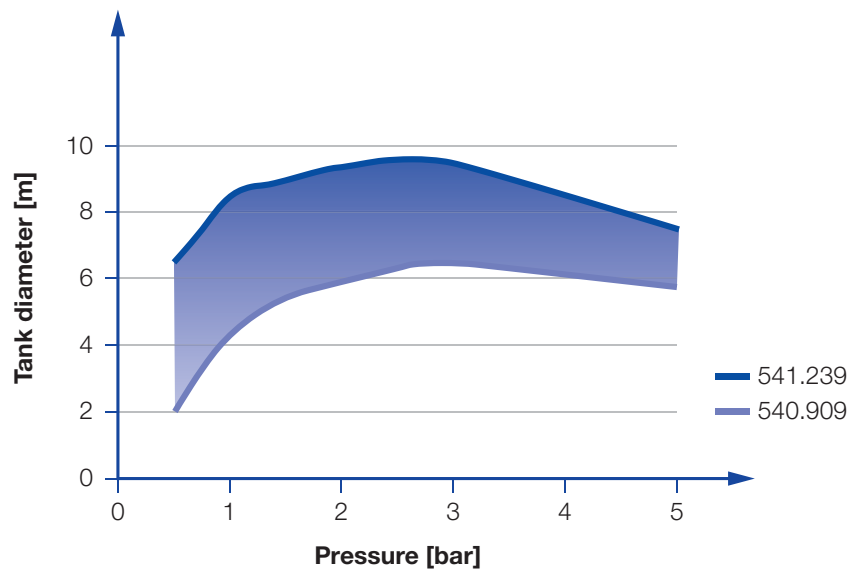

Installation
Operation in every direction is possible

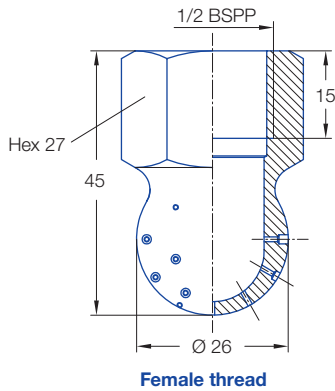

Overview of the tank diameter, depending upon the pressure of series 540/541



Spray angle 	Ordering number Type	E Ø [mm]	\dot{V} [l/min]					Max. tank diameter [m]
			p [bar] ($p_{\max} = 10$ bar)					
			0.5	1	2	3	at 40 psi [US gal/min]	
	540.909.16	0.8	9	13	18	22	6	6.5
	540.989.16	1.0	14	20	28	34	9	7.0
	541.109.16	1.5	29	40	57	70	18	7.5
	541.189.16	2.0	45	64	90	110	28	8.3
	541.239.16	2.3	59	83	118	145	37	9.5

E = narrowest free cross-section · NPT on request

The maximum tank diameter shown above applies for the recommended operating pressure and is indicative only. The cleaning result is also affected by the type of soiling.

Information on operation

In most applications, static spray balls do not deliver the same cleaning power as rotating nozzles, anyway they do have advantages that make them indispensable for certain tasks:

- No moving parts
- Self-draining
- Easy to inspect
- Proven use in hygienically sensitive environments

Should a rotating nozzle stop turning for some reason, parts of the tank may remain uncleaned. This cannot happen with spray balls. However, gaps can occur in the spray pattern if individual openings are blocked with soil.

Compared to rotating nozzles, static spray balls usually need two to three times the amount of liquid.



Static spray balls »RinseClean« Series 5B2/5B3

Series 5B2/5B3

The spray ball design has proven itself in many applications. It can be used in areas with high hygienic requirements and high temperatures. Our RinseClean spray ball is available with various slip-on connections, as well as in threaded or welded versions.



	Max. tank diameter [m]	0	1	2	3	4	5	6	7	8	9
--	-------------------------------	---	---	---	---	---	---	---	---	---	---

Material
316L SS,
Pin: 316L SS

Max. temperature
200 °C

Recommended operating pressure
2 bar

Installation
Operation in every direction is possible

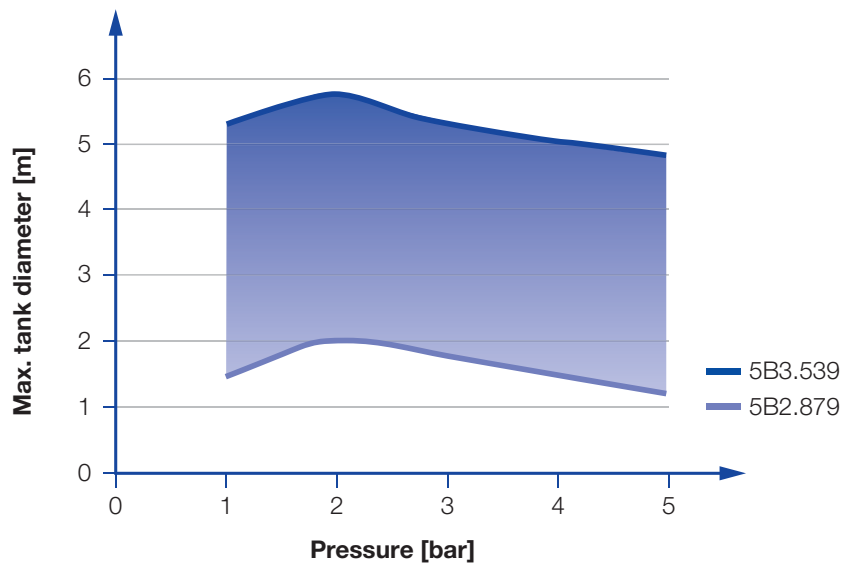

Overview of the tank diameter, depending upon the pressure of series 5B2/5B3

Connection options

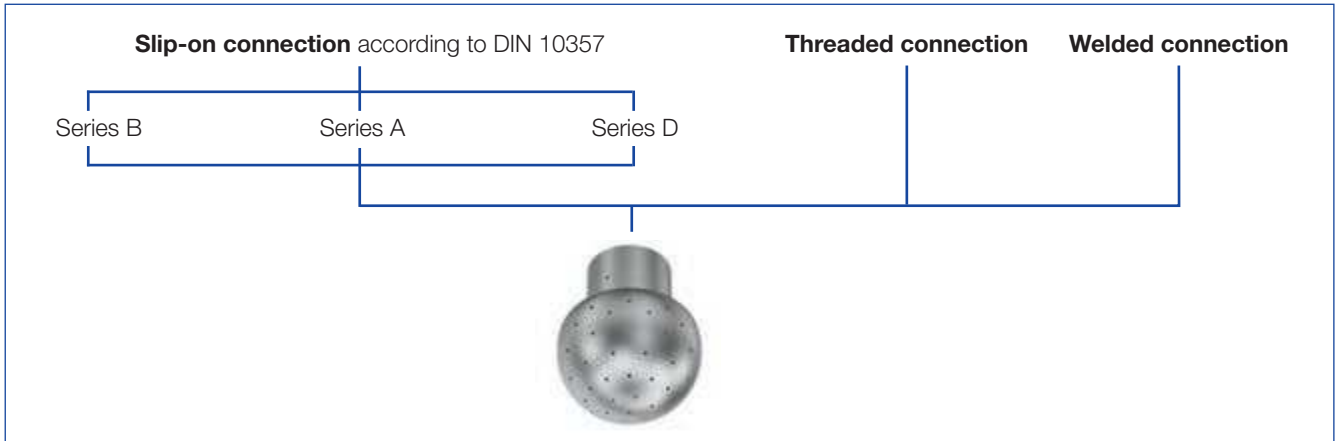

Slip-on connection

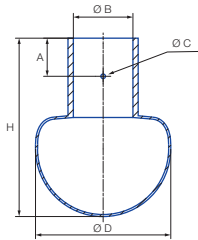

Dimensions slip-on connection according to DIN 10357



Pin 1

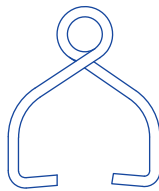

Pin 2-5

With the slip-on connection, the spray ball is pushed onto the customer's connection pipe and secured with the supplied cotter pin. Lechler offers the right connection sizes for the three most common pipe standards.

Pin	Ordering no.
1	095.013.1Y.06.55.0
2	095.013.1Y.06.58.0
3	095.013.1Y.06.56.0
4	095.013.1Y.06.59.0
5	095.013.1Y.06.57.0

Slip-on connection according to DIN EN 10357 series B (replaces DIN 11850 series 1)

Spray angle	Ordering no.	E Ø [mm]	V̇ [l/min]					Dimensions [mm]					Max. tank diameter [m]	
			p [bar] (p _{max} = 5 bar)					Ø D	Height H	Con- nection Ø B	Ø C	Distance to bore hole A		Pin
			0.5	1	2	3	at 40 psi [US gal/min]							
360° 	5B2.879.1Y.D0.80	0.8	8	11	15	18	4.7	20	37	8.2	2.2	9	1	2.0
	5B3.089.1Y.D1.20	1.0	25	35	50	61	15.5	28	42	12.2	2.2	9	1	2.2
	5B3.139.1Y.D1.20	1.6	33	46	65	80	20.2	28	42	12.2	2.2	9	1	2.3
	5B3.209.1Y.D1.80	1.5	50	71	100	123	31.0	28	42	18.2	2.2	9	1	2.5
	5B3.309.1Y.D2.20	1.7	90	127	180	221	55.8	64	84	22.2	2.2	18	2	3.5
	5B3.379.1Y.D2.80	2.1	130	184	260	318	80.7	64	84	28.2	2.2	18	3	5.2
	5B3.389.1Y.D4.00	2.1	140	198	280	343	86.9	64	84	40.3	2.2	18	4	5.2
	5B3.409.1Y.D3.40	2.3	160	226	320	392	99.3	64	84	34.2	2.2	18	4	5.2
	5B3.449.1Y.D2.80	3.0	205	290	410	502	127.2	64	84	28.2	2.2	18	3	5.4
	5B3.489.1Y.D3.40	2.9	255	361	510	625	158.2	64	84	34.2	2.2	18	4	5.5
5B3.499.1Y.D4.00	2.8	270	382	540	661	167.5	64	84	40.3	2.2	18	4	5.5	
5B3.539.1Y.D5.20	3.2	335	474	670	821	207.8	90	111	52.3	3.0	25	5	5.6	
180° 	5B3.083.1Y.D1.80	1.2	25	35	50	61	15.5	28	42	18.2	2.2	9	1	2.2
	5B3.253.1Y.D2.20	1.8	65	92	130	159	40.3	64	84	22.2	2.2	18	2	3.0
	5B3.323.1Y.D2.80	2.3	100	141	200	245	62.0	64	84	28.2	2.2	18	3	3.5
	5B3.463.1Y.D5.20	3.3	230	325	460	563	142.7	90	111	52.3	3.0	25	5	5.4
180° 	5B3.114.1Y.D1.80	1.4	30	42	60	74	18.6	28	42	18.2	2.2	9	1	2.2
	5B3.274.1Y.D2.20	2.3	75	106	150	184	46.5	64	84	22.2	2.2	18	2	3.0
	5B3.394.1Y.D2.80	3.0	145	205	290	355	90.0	64	84	28.2	2.2	18	3	5.0
	5B3.444.1Y.D5.20	3.2	200	283	400	490	124.1	90	111	52.3	3.0	25	5	5.2

E = narrowest free cross-section

Continued on next page.



Static spray balls »RinseClean« Series 5B2/5B3

Slip-on connection

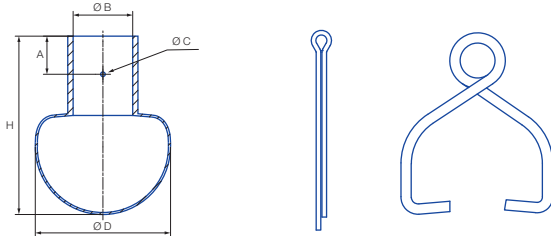



Dimensions slip-on connection according to DIN 10357

Pin 1

Pin 2-5



Slip-on connection according to DIN EN 10357 series A (replaces DIN 11850 series 2)

Spray angle 	Ordering no. Type	E Ø [mm]	V [l/min]					Dimensions [mm]						Max. tank diameter [m]
			p [bar] (p _{max} = 5 bar)					Ø D	Height H	Con- nection B	Ø C	Distance to bore hole A	Pin	
			0.5	1	2	3	at 40 psi [US gal/min]							
360° 	5B3.149.1Y.D2.90	0.9	35	50	70	86	21.7	64	84	29.2	2.2	18	3	2.3
	5B3.299.1Y.D2.90	1.5	83	117	165	202	51.2	64	84	29.2	2.2	18	3	3.2
	5B3.359.1Y.D2.90	1.9	115	163	230	282	71.3	64	84	29.2	2.2	18	3	5.0
	5B3.399.1Y.D2.90	2.2	150	212	300	367	93.1	64	84	29.2	2.2	18	3	5.2
	5B3.429.1Y.D2.90	2.6	180	255	360	441	111.7	64	84	29.2	2.2	18	3	5.2
	5B3.539.1Y.D5.30	3.2	335	474	670	821	207.8	90	111	53.3	3.0	25	5	5.6

E = narrowest free cross-section

The maximum tank diameter shown above applies for the recommended operating pressure and is indicative only. The cleaning result is also affected by the type of soiling.

Slip-on connection according to DIN EN 10357 series D (ASME BPE 1997, OD-tube compatible)

Spray angle 	Ordering no. Type	E Ø [mm]	V [l/min]					Dimensions [mm]						Max. tank diameter [m]
			p [bar] (p _{max} = 5 bar)					Ø D	Height H	Con- nection B	Ø C	Distance to bore hole A	Pin	
			0.5	1	2	3	at 40 psi [US gal/min]							
360° 	5B3.089.1Y.A1.00	1.0	25	35	50	61	15.5	28	42	9.8	2.2	9	1	2.2
	5B3.209.1Y.A1.90	1.5	50	71	100	123	31.0	28	42	19.3	2.2	9	1	2.5
	5B3.309.1Y.A1.90	1.7	90	127	180	221	55.8	64	84	19.3	2.2	18	1	3.5
	5B3.379.1Y.A2.60	2.1	130	184	260	318	80.7	64	84	25.6	2.2	18	3	5.2
	5B3.449.1Y.A3.80	3.0	205	290	410	502	127.2	64	84	38.3	2.2	18	4	5.4
	5B3.539.1Y.A5.10	3.2	335	474	670	821	207.8	90	111	51.1	3.0	25	5	5.6

E = narrowest free cross-section

The maximum tank diameter shown above applies for the recommended operating pressure and is indicative only. The cleaning result is also affected by the type of soiling.

Slip-on information

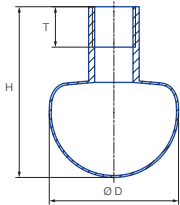

- Pin made of 316L SS is included.
- Depending on diameter of adapter, the flow rate can increase due to leakage between connecting pipe and static spray ball.

Threaded connection



Female thread
(exception 5B2.872.1Y.AA.00 has a male thread)

Threaded connection

Spray angle 	Ordering no.	Con- nection BSPP	E Ø [mm]	V̇ [l/min]					Dimensions [mm]			Max. tank diameter [m]
	Type			p [bar] (p _{max} = 5 bar)					Ø D	Height H	Screw-in length T	
				0.5	1	2	3	at 40 psi [US gal/min]				
360° 	5B2.879.1Y.AA.00	1/8 male	0.8	8	11	15	18	4.7	20	37	8	2.0
	5B3.309.1Y.AH.00	1/2	1.9	90	127	180	221	55.8	64	84	14	3.5
	5B3.379.1Y.AN.00	1	2.1	130	184	260	318	80.7	64	84	18	5.2
	5B3.539.1Y.AW.00	2	3.1	335	474	670	821	207.8	90	111	24	5.6



E = narrowest free cross-section

The maximum tank diameter shown above applies for the recommended operating pressure and is indicative only. The cleaning result is also affected by the type of soiling.

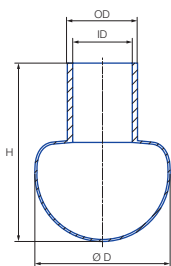
Welded connection



Welded connection according to ISO 2037

Spray angle 	Ordering no.	E Ø [mm]	V̇ [l/min]					Dimensions [mm]			Max. tank diameter [m]
	Type		p [bar] (p _{max} = 5 bar)					Ø D	Height H	Dimensions of the connection piece	
			0.5	1	2	3	at 40 psi [US gal/min]				
360° 	5B2.879.1Y.W1.20	0.8	8	11	15	18	4.7	20	37	OD 12 ID 10	2.0
	5B3.089.1Y.W1.20	1.0	25	35	50	61	15.5	28	42	OD 12 ID 10	2.2
	5B3.209.1Y.W1.70	1.5	50	71	100	123	31.0	28	42	OD 17.2 ID 15.2	2.5
	5B3.309.1Y.W2.50	1.7	90	127	180	221	55.8	64	84	OD 25 ID 22.6	3.5
	5B3.379.1Y.W2.50	2.1	130	184	260	318	80.7	64	84	OD 25 ID 22.6	5.2
	5B3.449.1Y.W3.80	3.0	205	290	410	502	127.2	64	84	OD 38 ID 35.6	5.4

E = narrowest free cross-section

The maximum tank diameter shown above applies for the recommended operating pressure and is indicative only. The cleaning result is also affected by the type of soiling.

