



# Multi-channel flat jet nozzles for air Whisperblast®, metallic versions Series 600.562.1Y

## Series 600.562.1Y

The multi-channel flat jet nozzles of the 600.562 series are ideal for applications with restricted space. In addition, the nozzle material (316L SS) makes them resistant to increased pressures and temperatures.

The projecting tips at the nozzle outlet prevent air penetration into human skin. These nozzles comply with the OSHA standards.

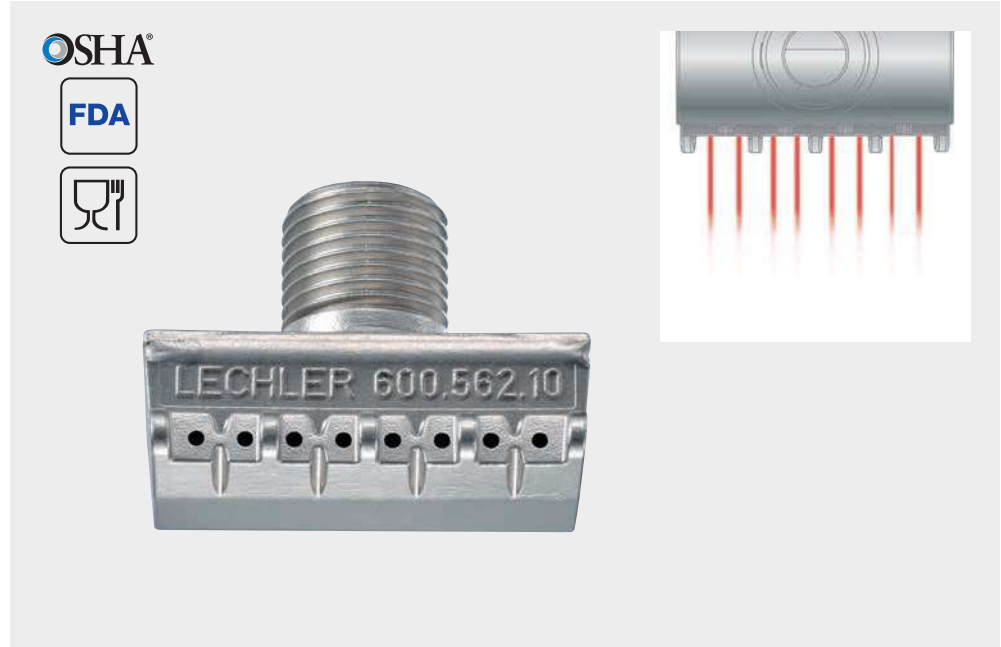

OSHA®

FDA

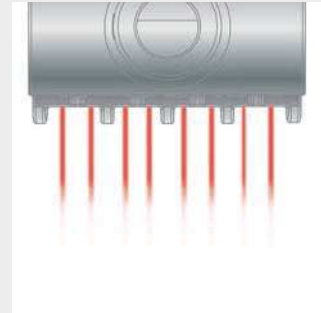

**Cost savings**

**8%**



**Noise reduction**

**14%**



**Material**

Stainless steel  
316L SS



**Blowing force**

1.2 N at 2 bar



**Noise level**

71 db(A) at 2 bar



**Air consumption**

$V_{LN} = 9 \text{ m}^3/\text{h}$  at 2 bar



**Pressure**

$p_{max} = 30 \text{ bar}$



**Max. temperature**

550 °C

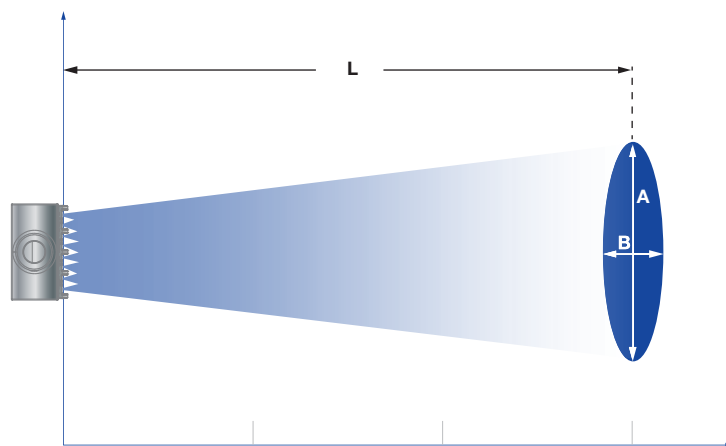

Jet pattern of 600.562 nozzle series

| Pressure:        | 1 bar | 3 bar | 5 bar |
|------------------|-------|-------|-------|
| Distance L [mm]: | 510   | 850   | 900   |

Jet dimensions at L

|         |     |     |     |
|---------|-----|-----|-----|
| A [mm]: | 114 | 200 | 230 |
| B [mm]: | 100 | 155 | 190 |

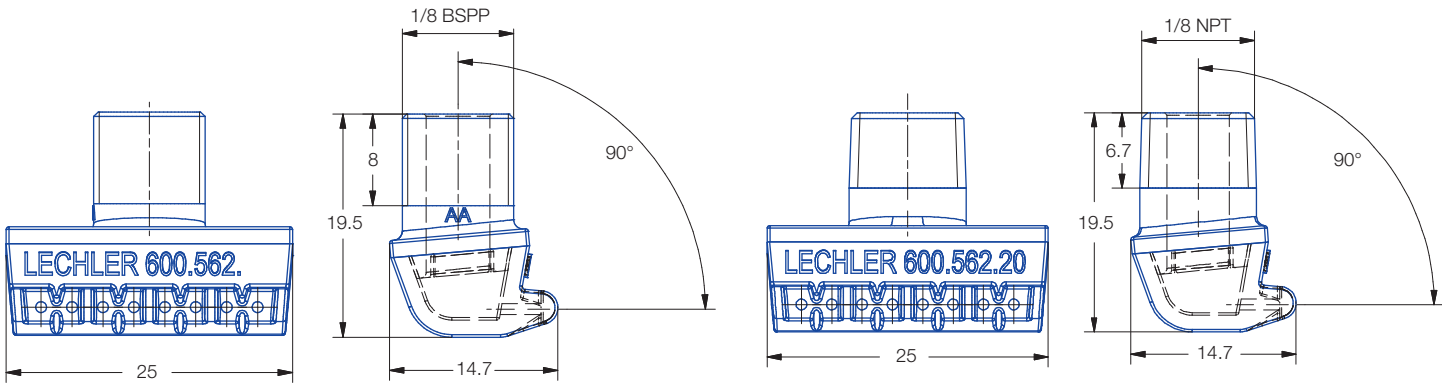

### Technical data

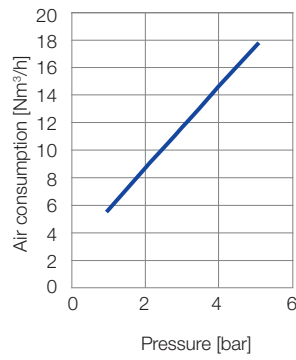
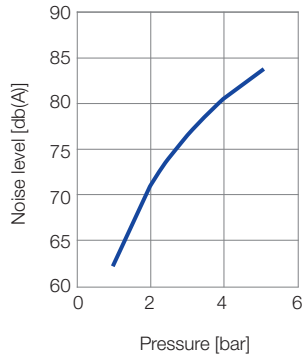
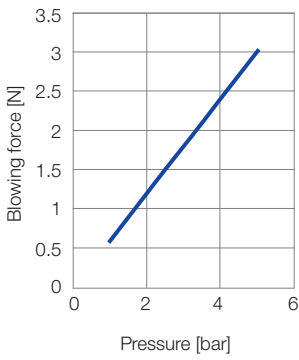

| Ordering no.               |          |          |         |
|----------------------------|----------|----------|---------|
| Type                       | Mat. no. | Code     |         |
|                            | 1Y       |          |         |
| Stainless steel<br>316L SS |          | 1/8 BSPP | 1/8 NPT |
| 600.562.                   | ○        | 10       | -       |
| 600.562.                   | ○        | -        | 20      |

**Example**    **Type**    +    **Mat. no.**    +    **Code**    =    **Ordering no.**  
**of ordering:**    600.562.    +    1Y       +    10       =    600.562.1Y.10